



Separation of Monoclonal Antibody and Protein Aggregates Induced by Thermal Denaturation, using a Novel Size Exclusion Chromatography Column

Justin Steve and Atis Chakrabarti, Ph.D.
Tosoh Bioscience LLC, King of Prussia, PA



Objective

The objective of this study is to separate the aggregate and other impurities formed under native and forced denatured conditions, such as acid denaturation and thermal denaturation, using a TSKgel UltraSW Aggregate, 3 μm , 30 nm pore size, 7.8 mm ID \times 30 cm SEC (Size Exclusion Chromatography) column.



Introduction – Forced Degradation

- Degradation studies of biotherapeutic proteins are necessary to test stability.¹
- The best case for testing the suitability of a method is using real-time stability samples containing all relevant degradation products that might occur over time.¹
- But due to some factors, such as product development timeline, process characteristics, excipients, and other environmental factors, a forced degradation study can be used as an alternative.¹
- Forced degradation is synonymous to stress testing.¹
- Forced degradation studies play a critical role in the development of therapeutic proteins.¹

¹J Pharm Sci. 2012 Mar;101(3):895-913.



Introduction – Forced Degradation

- Forced degradation studies are carried out for the following reasons:
 - to understand the effects of modification and conjugation steps on the physicochemical stability of the antibody
 - to develop and validate a stability-indicating method
 - to determine degradation pathways during the development phase
 - to identify impurities related to biotherapeutic proteins or excipients
 - to understand the chemistry of the biotherapeutic protein
 - to generate more stable formulations containing biotherapeutic proteins since controlling and preventing aggregation is critical to the development of safe and effective antibody drug products
 - to generate a degradation profile that mimics a formal stability study under ICH (International Conference on Harmonisation) conditions
- Typical stress methods are exposure to (a) elevated temperatures (b) pH (c) freeze-thaw cycles (d) mechanical stress (e) oxidation (f) light and (g) various materials and devices used in clinics during final administration.
- Here we have used heat and pH as stress for forced degradation to induce aggregation.



Introduction – Importance of the Separation of the Aggregates

- Protein aggregation is a biological phenomenon.
- Aggregation is a major problem in therapeutic-protein development.
- There are many reasons why the aggregates form.
- Mechanisms of protein aggregation are still not fully understood yet.
- Mostly the mis-folded proteins have a tendency to form aggregate.
- Both intra- or extra-cellular protein aggregates are found.
- Freeze-thaw cycles can cause an aggregation of an already purified protein sample stored in a freezer¹.
- One plausible mechanism is that aggregation is driven or catalyzed by the presence of a small amount of a contaminant or impurities.
- These protein aggregates are often toxic; protein aggregates have been implicated in a wide variety of diseases known as amyloidosis, including Alzheimer's, Parkinson's and prion disease.
- Even if any of these aggregates and other impurities are non-toxic or harmless, these still need to be removed, since the presence of the impurities will reduce the potency of the drug formulation.
- Monoclonal antibody proteins, widely being used in the field of biotherapeutics, must be free from these aggregate impurities.

¹J Pharm Sci. 2012 Mar;101(3):895-913.



Introduction

- Separation of the pure antibody monomer needs to be very well resolved from its dimer and higher order aggregates.
- Similarly, for quality control and regulatory purposes the separation of antibody fragments is also very much essential.
- The following two figures will summarize the structures of the monoclonal antibodies and the large metalloproteins used in this study.

Introduction: Structure of Antibody (IgG) and Possible Variants as Impurities

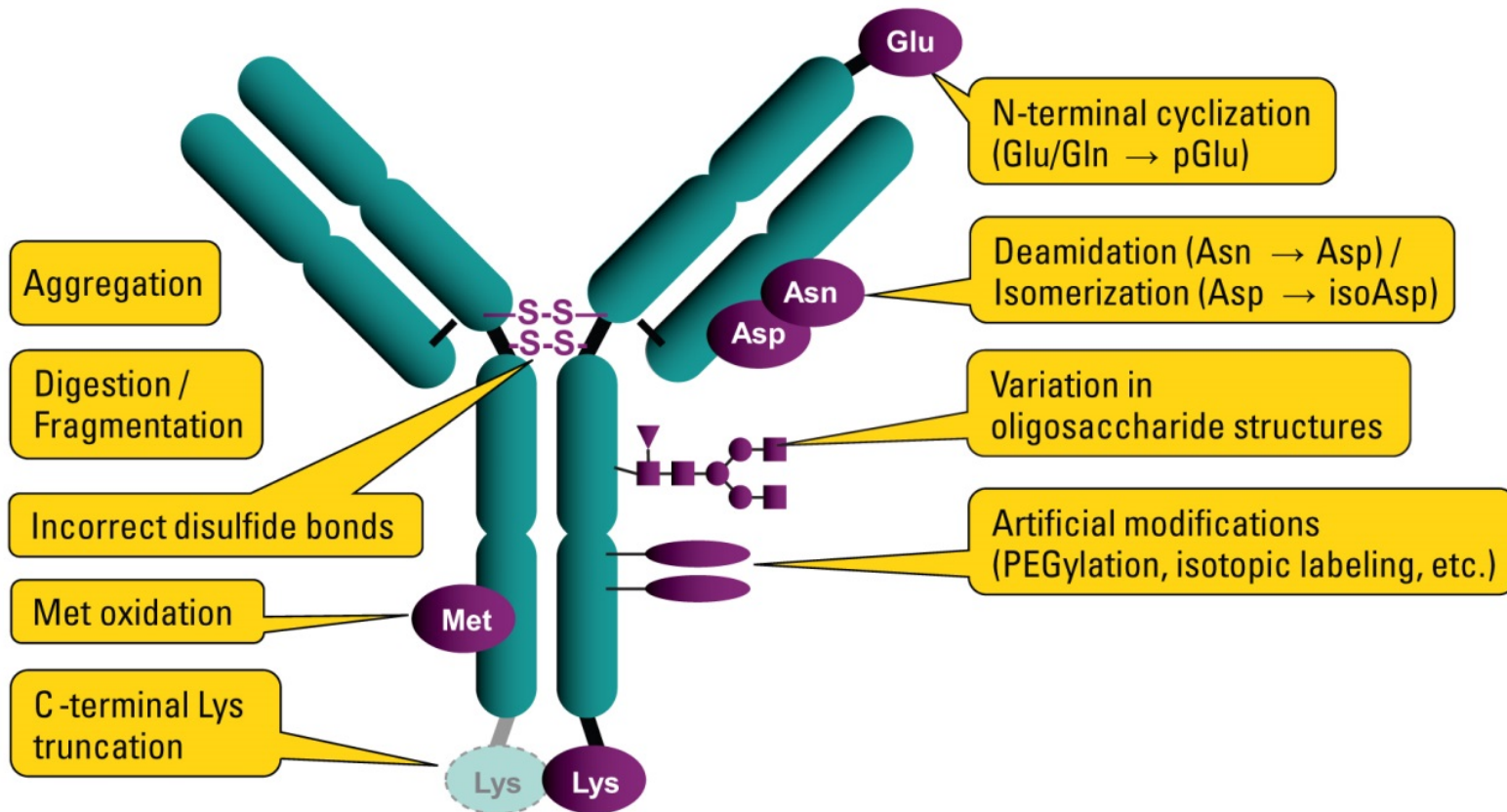

- Aggregation impurities are one of these many different types of variants.
- These impurities are likely to impact the therapeutic effect or safety, thus must be fully evaluated.

Introduction: Structure of Ferritin and Apoferritin

3-D image of ferritin illustrating 24 subunit structure²

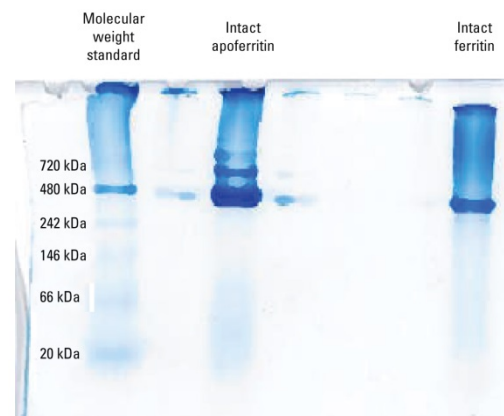
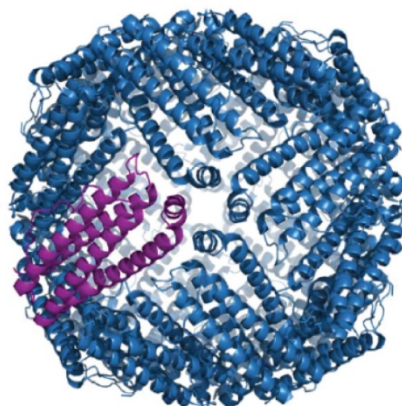

- Ferritin is a large hydrophobic, globular, red-brown metalloprotein of 450 kDa consisting of 24 identical subunits, each of approximately 18.5 kDa.
- Ferritin can contain up to 4,500 Fe atoms per molecule as an average in its hollow, nearly spherical interior in the form of a Fe(O)OH type mineral core.
- Ferritin is present in every cell type and serves to store iron in a non-toxic form, to deposit it in a safe form, and to transport it to areas where it is required.
- Ferritin is a commercially available, bioavailable supplement.
- It is widely used as a molecular weight standard for making calibration curves for size exclusion chromatography columns.
- The native PAGE analysis carried out using standard protocol shows that both ferritin and apoferritin contain a considerable amount of dimer and higher order aggregates at room temperature.
- TSKgel UltraSW Aggregate column is used to separate these aggregates under native conditions.

²J Pharm Sci. 2011 Dec;100(12):5081-95.



Introduction: Classification of Various Techniques to Analyze Protein Aggregation³

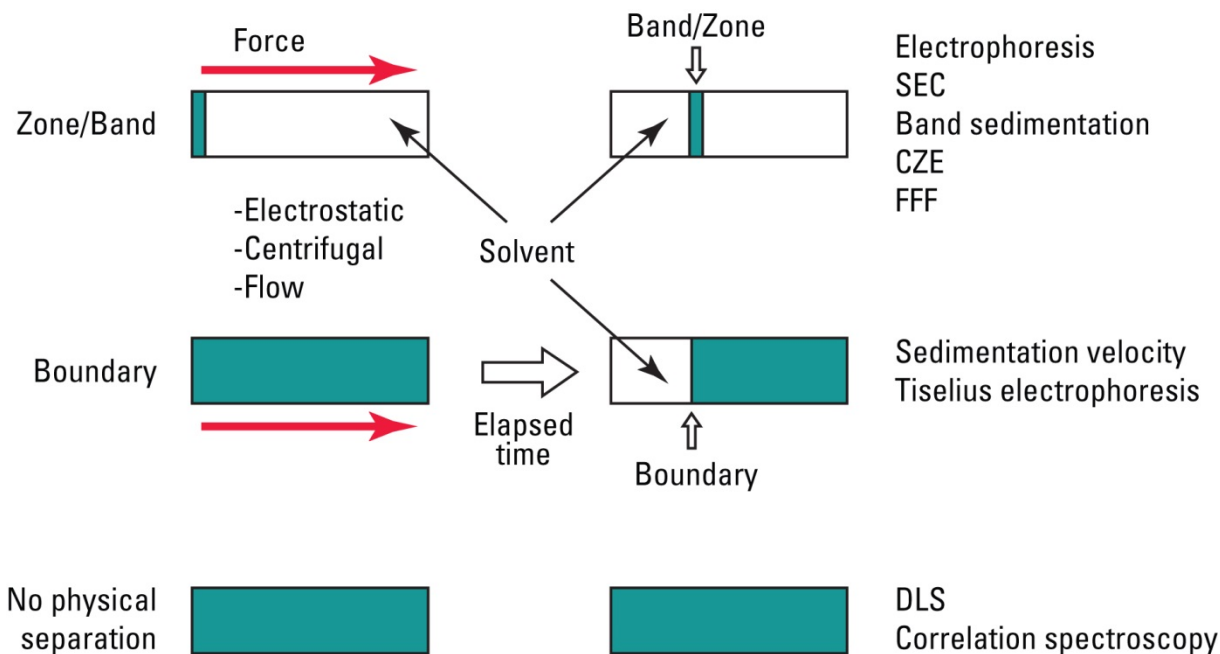

- There are many different techniques to analyze protein aggregation.
- Size exclusion chromatography is commonly used as a final polishing step in the preparation of biopharmaceuticals and widely used in QC for assessment of product purity and concentrations.
- Size exclusion chromatography is one of the most important techniques to separate the protein aggregates.

³BioProcess International 4(10):42-43 (November 2006)



Introduction: Molecular Exclusion Limit and the Efficiency of the Evaluation of Higher Order Aggregates

- To fully evaluate the aggregates, a size exclusion column is needed which has a large enough molecular exclusion limit, so that the higher order aggregates are not excluded in the void but separated as a function of hydrodynamic volume.
- We have developed a TSKgel UltraSW Aggregate column, which is a silica-based, 7.8 mm ID × 30 cm analytical SEC column packed with newly developed 30 nm pores, 3 μm particles.
- This column is designed especially for mAb analysis and particularly for the separation of the aggregates.
- The larger pore size with an estimated exclusion limit of $\sim 2 \times 10^6$ Da provides improved separation and quantitation of mAb aggregates and oligomers.
- Here we report the use of a number of monoclonal antibodies and proteins of various sizes in separating the corresponding protein aggregates.



TSKgel UltraSW Aggregate Column: Product Attributes

Column	TSKgel UltraSW Aggregate
Column dimensions	7.8 mm ID × 30 cm
Base material	Silica gel
Functional group	Diol
Particle size	3 μm
Pore size	30 nm
Separation range (for globular proteins)	$1 \times 10^4 - 2 \times 10^6$ Da
Applications	Separation of mAb aggregates



Protein Calibration Curve for TSKgel UltraSW Aggregate Column

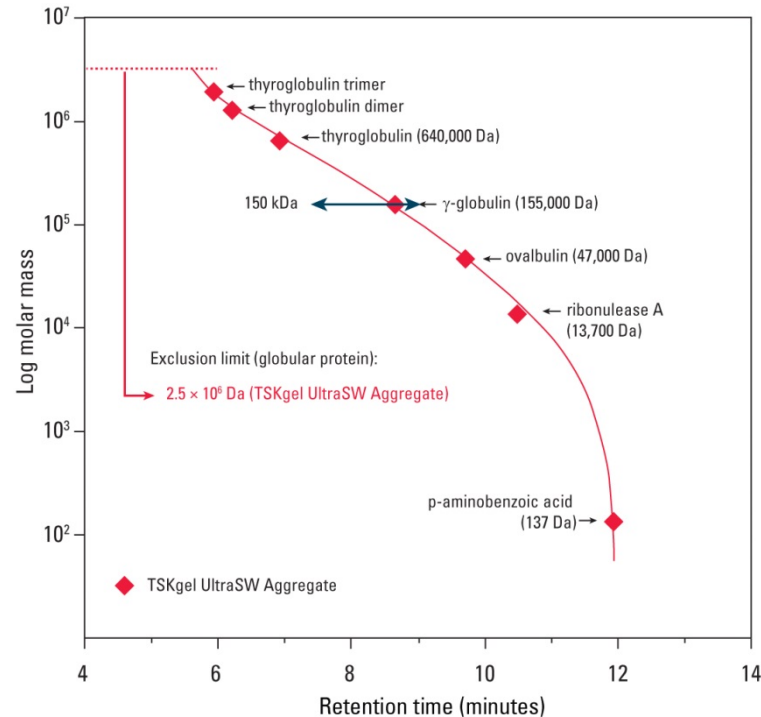

- The TSKgel UltraSW Aggregate column utilizes a unique pore-controlled technology, which produces a shallow calibration curve in the molecular weight region of a typical monoclonal antibody.
- The calibration curve shows a separation range up to around 2 million Da, which implies better resolution of the aggregate/multimer of a mAb.



Material and Methods

Columns

- TSKgel UltraSW Aggregate, 3 μm , 30 nm, 7.8 mm ID \times 30 cm
- TSKgel G3000SW_{XL}, 5 μm , 25 nm, 7.8 mm ID \times 30 cm
- All TSKgel columns were manufactured by Tosoh (Tokyo, Japan).

Instrumentation: HPLC Systems

- Tosoh liquid chromatograph equipped with pump (DP-8020), column oven (CO-8020), UV detector (UV-8020), and data processor (LC-8020 model II)
- Agilent 1200 (Chemstation - Rev B.04.01)
- Agilent 1100 (Chemstation - Rev B.04.02)



Material and Methods

Samples

- Standard TSKgel SW_{xL} test mixture: thyroglobulin, γ -globulin, ovalbumin, ribonuclease A, para-Aminobenzoic acid (PABA)
- Pullulan standards were obtained from Showa Denko (Tokyo, Japan).
- Monoclonal antibodies:
 - mAb-02 from Boehringer-Ingelheim (gift from Tosoh Bioscience GmbH); concentration: 4.5 g/L in glycine/Na phosphate, pH 6.0
 - mouse-human chimeric IgG (Erbitux[®])
- Protein samples:
 - Ferritin – Sigma, 4.7 mg/mL, in saline (0.9% NaCl in water) solution, stored at 2-8 °C
 - Apoferritin – Sigma, 5.0 mg/mL, in 50% glycerol and 0.075 mol/L sodium chloride, stored at -20 °C



Material and Methods

Acid denaturation of monoclonal antibody

- After reducing the pH of the BI-mAb-02 sample solution down to 4.7 by dilute phosphoric acid, aliquots were analyzed at 5, 20 and 50 minutes and the response was compared to that of the original sample solution.



Material and Methods

Heat denaturation of monoclonal antibody

- pH 4.7 was initially used for the mAb thermal denaturation study. Because the degradation occurred fast, the pH was increased to pH 5.5.
- Denaturation at pH 5.5 and a temperature of 60 °C was monitored as a function of time of incubation.
- 50 μL of antibody, pH 6.0, was mixed with 50 μL of 0.1 mol/L phosphate buffer, pH 4.65; final pH was 5.5; 20 μL was injected.



Material and Methods

Heat denaturation of ferritin and apoferritin

- A set of six, 0.3 mL HPLC vials each containing 100 μ L stock solution of ferritin was used for protein thermal denaturation.
- Separately another set of 6 vials was prepared for thermal denaturation of apoferritin in the same manner.
- Thermal denaturation of both of the proteins was carried out at 60 °C using an electric heating block. Individual sample vials were tightly capped and exposed to the heat for 5, 20, 30, 45, and 60 minutes.
- Samples were analyzed by HPLC at the end of each incubation time period.



Chromatographic Conditions

Monoclonal antibody

- Mobile phase: 100 mmol/L potassium phosphate buffer, 100 mmol/L sodium sulfate, pH 6.7 + 0.05% NaN_3 ; unless mentioned otherwise
- Flow rate: 1.0 mL/min (unless mentioned otherwise)
- Detection: UV @ 280 nm
- Temperature: ambient/25 °C except during heat denaturation study
- Injection vol.: 10 μL



Material and Methods

Papain digested IgG

- Mobile phase: 200 mmol/L phosphate buffer + 0.05% NaN₃, pH 6.7
- Flow rate: 1.0 mL/min
- Detection: UV @ 280 nm
- Temperature: 25 °C
- Injection vol.: 10 µL (100 µg)
- Samples: 10 g/L IgG digested with papain for 0-24 hr using standard papain digestion protocol, published elsewhere



Chromatographic Conditions

Ferritin and apoferritin

- Mobile phase: 50 mmol/L potassium phosphate (monobasic), 50 mmol/L sodium phosphate (dibasic), 100 mmol/L sodium sulfate, 0.05% NaN₃, pH 6.7
- Flow rate: 1 mL/min
- Detection: UV @ 280 nm
- Temperature: 30 °C
- Injection vol.: 10 µL



Material and Methods

- High purity HPLC grade Sigma Aldrich chemicals were used in this study.
- High purity 18.2 m.Ohm-cm quality water was used to make buffer and samples.



Figure 1: Analysis of Thyroglobulin Monomer, Dimer and Aggregates

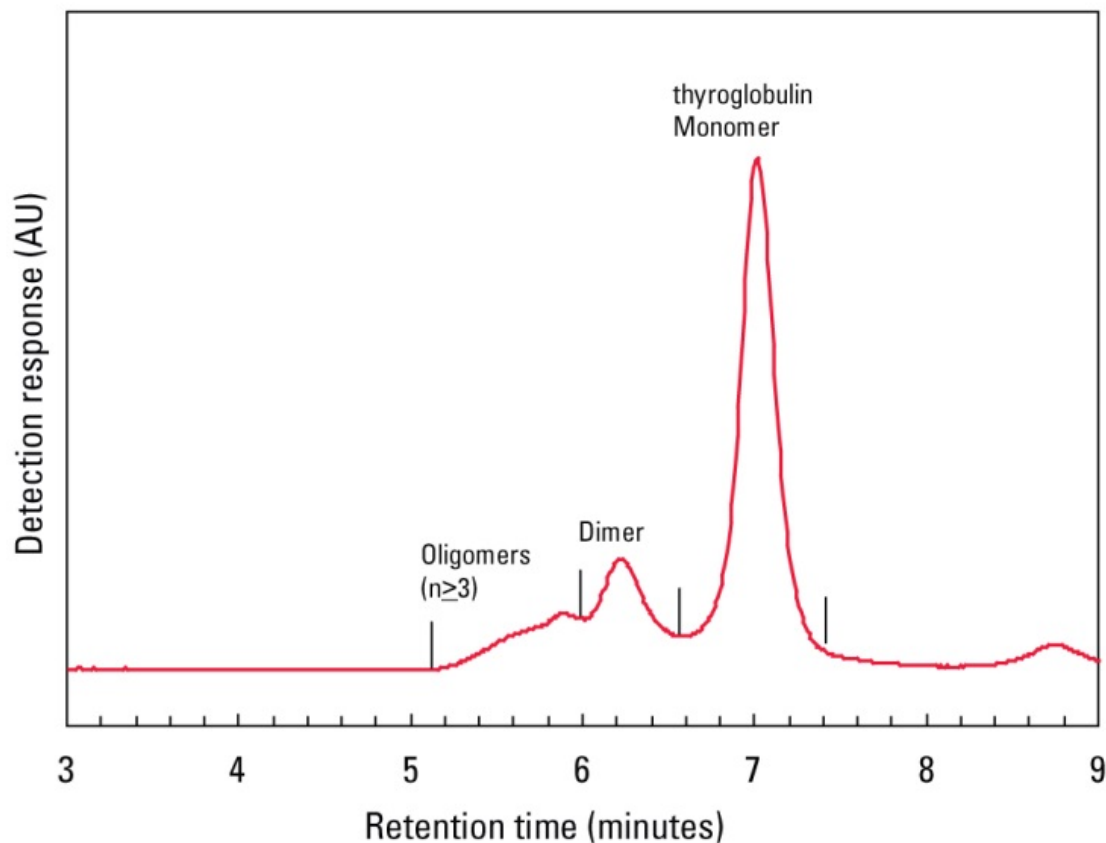

The larger molecular weight exclusion limit of the TSKgel UltraSW Aggregate column results in the better separation of a thyroglobulin monomer from its dimer and higher order aggregates.



Figure 2: Analysis of Chimeric IgG Erbitux

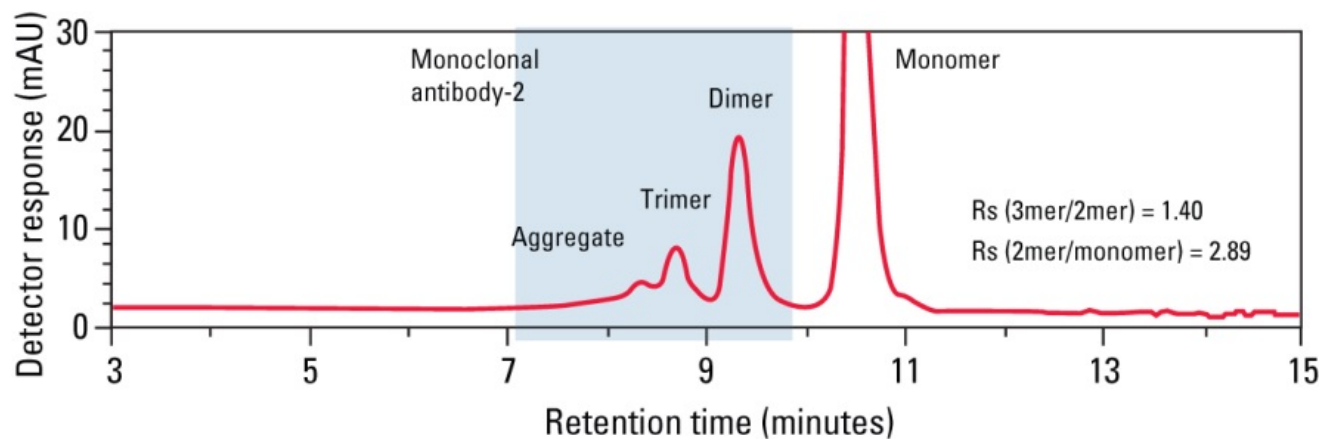

Column: TSKgel UltraSW Aggregate, 3 μ m, 7.8 mm ID \times 30 cm
Mobile phase: 0.2 mol/L phosphate buffer, pH 6.7 + 0.05% NaN_3
Flow rate: 0.8 mL/min
Detection: UV @ 280 nm
Temperature: 25 $^{\circ}$ C
Sample: monoclonal antibody-2
(mouse-human chimeric IgG, Erbitux), 10 μ L

The TSKgel UltraSW Aggregate column showed superior resolution of mAb trimer and dimer.



Figure 3: Analysis of Monoclonal Antibody

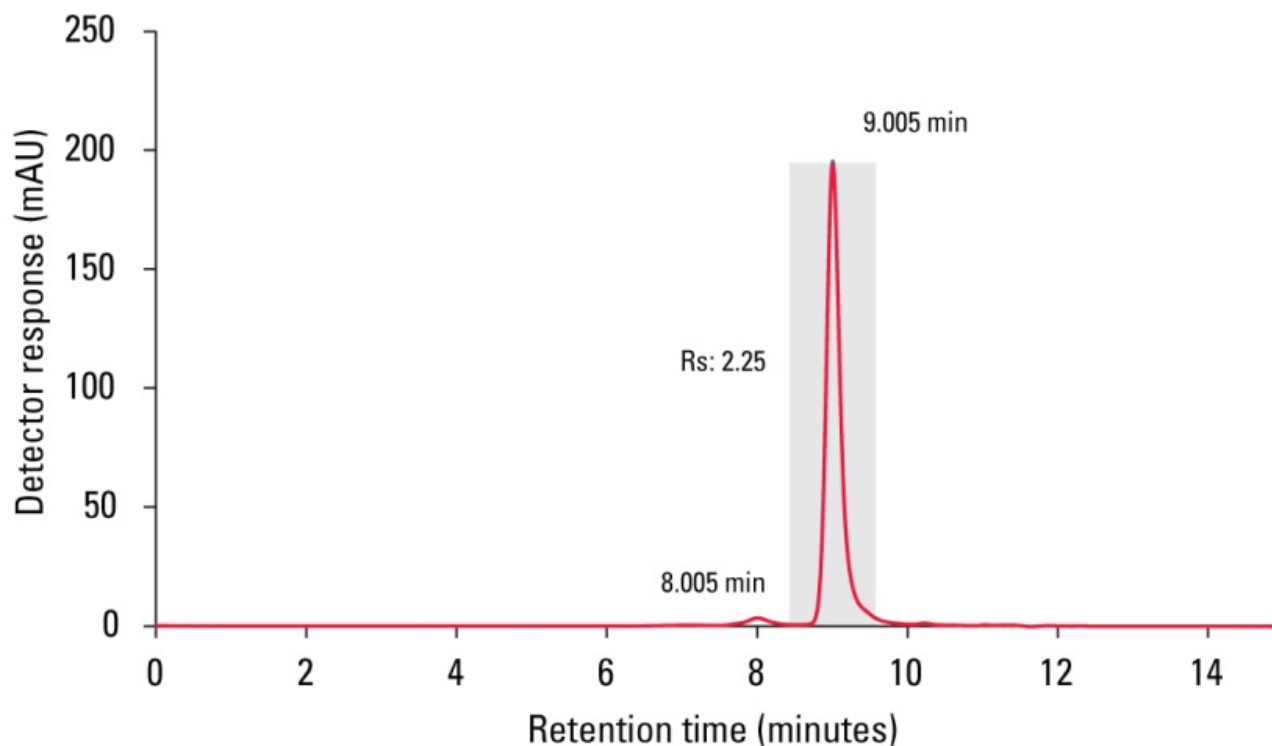

Analysis of mAb-02 by the TSKgel UltraSW Aggregate column yielded good separation between the monomer and dimer peaks.



Figure 4: Analysis of Monomer, Dimer and Fragments

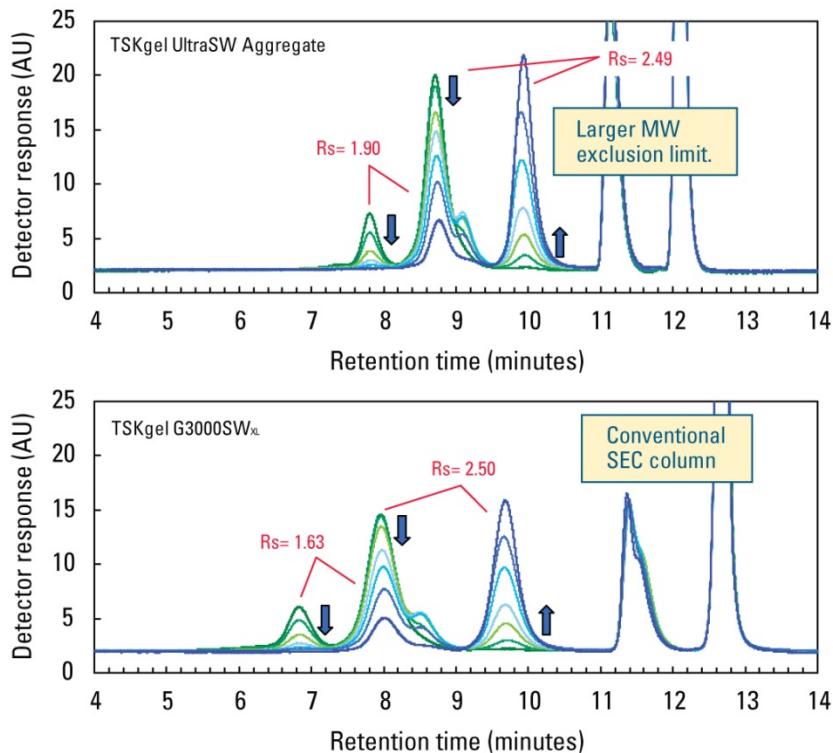

The TSKgel UltraSW Aggregate column, packed with 3 μm particles and 30 nm pores, has a larger molecular weight exclusion limit compared to the conventional TSKgel G3000SW_{xL} column packed with 5 μm particles and 25 nm pores, and yields higher resolution between the monomer and dimer of IgG.

Column	Undigested IgG				IgG digested with papain for 1,440 min	
	ET (min) (Monomer)	TP (Dimer)	TP (Monomer)	Rs (d/m)	TP (Fragments)	Rs (m/f)
TSKgel UltraSW Aggregate, 7.8 mm ID \times 30 cm	8.710	5,563	4,279	1.90	7,807	2.49
TSKgel G3000SW _{xL} , 7.8 mm ID \times 30 cm	7.963	1,912	1,781	1.63	3,883	2.50



Figure 5: Analysis of mAb Aggregates Formed by Forced Denaturation by Acid at pH 4.7

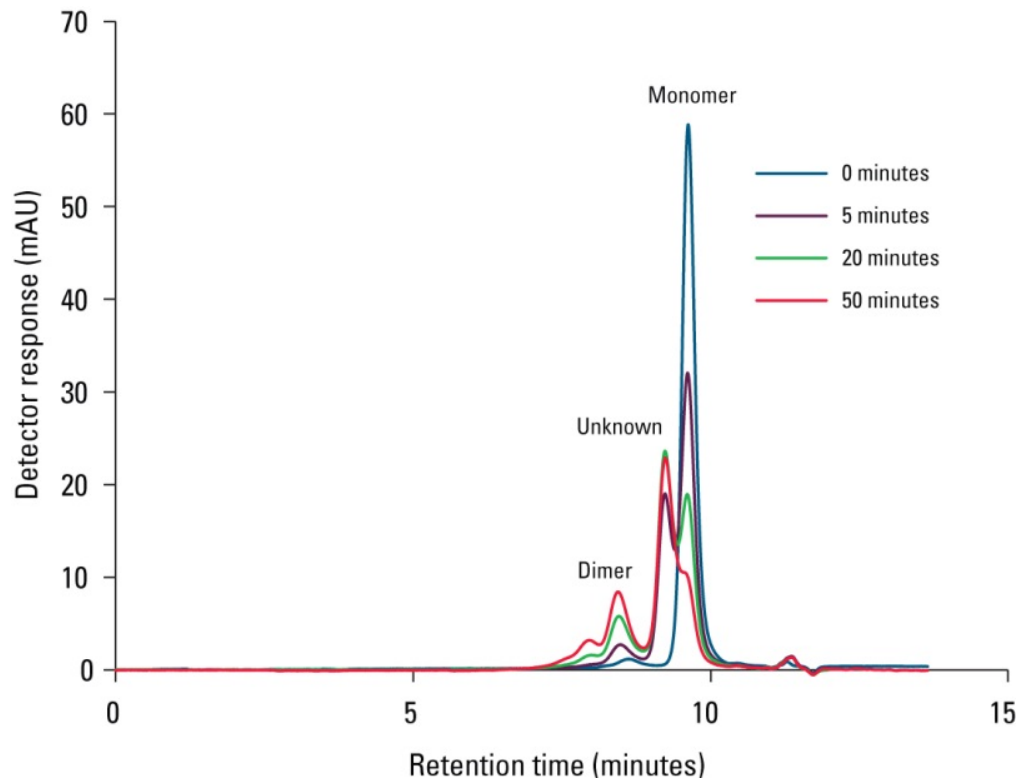

- The degradation of the monoclonal antibody creates a larger MW entity (unknown) that elutes directly after the monomer and before the dimer. Continued decay increases both peaks, but more so for the dimer.
- Clearly, the dimer increases in size while the peak height of the monomer decreases. Hints of higher order 'multimers' show between 7 and 8 minutes.



Figure 6: Analysis of mAb Aggregates Formed by Heat Denaturation at 60 °C at pH 5.5

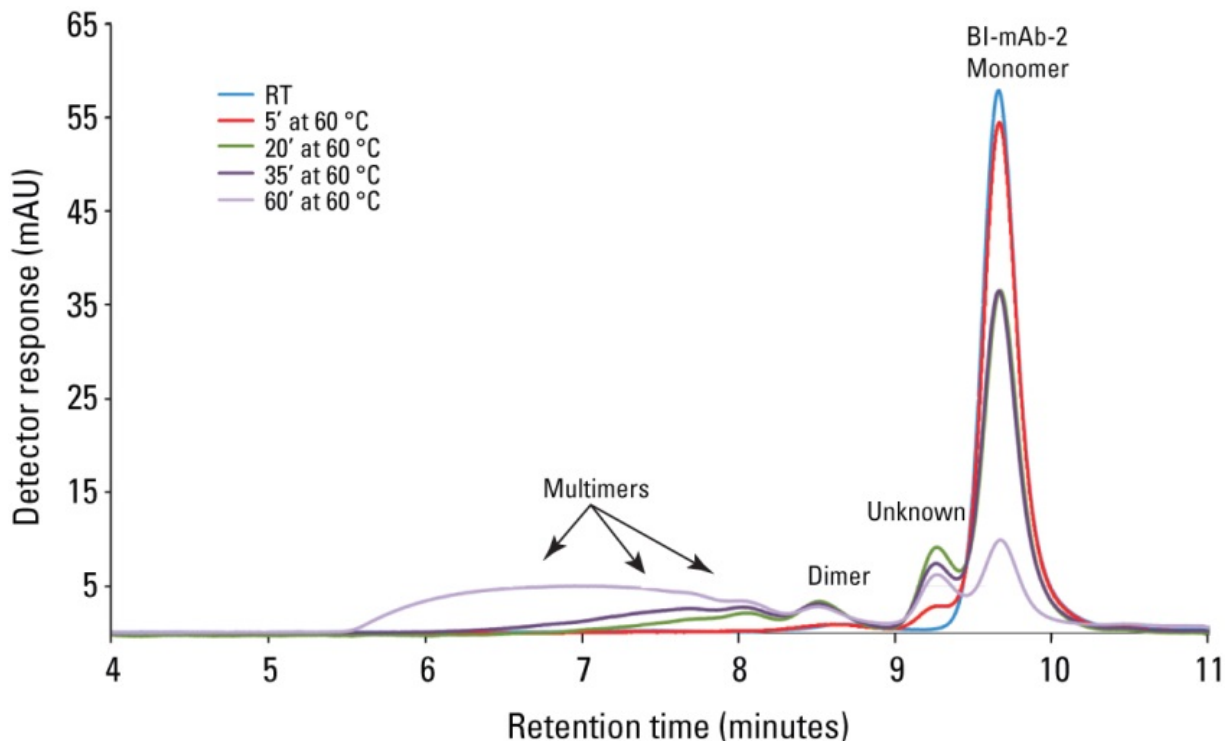

- In addition to the 'unknown' aggregate, we now see what is presumably the dimer peak at 8.5 minutes, and several higher order aggregate peaks.
- Heating for one hour at 60 °C results in almost complete breakdown of the monoclonal antibody and the formation of very large aggregates that extend till the exclusion volume of the column.



Figure 7: Analysis of Ferritin

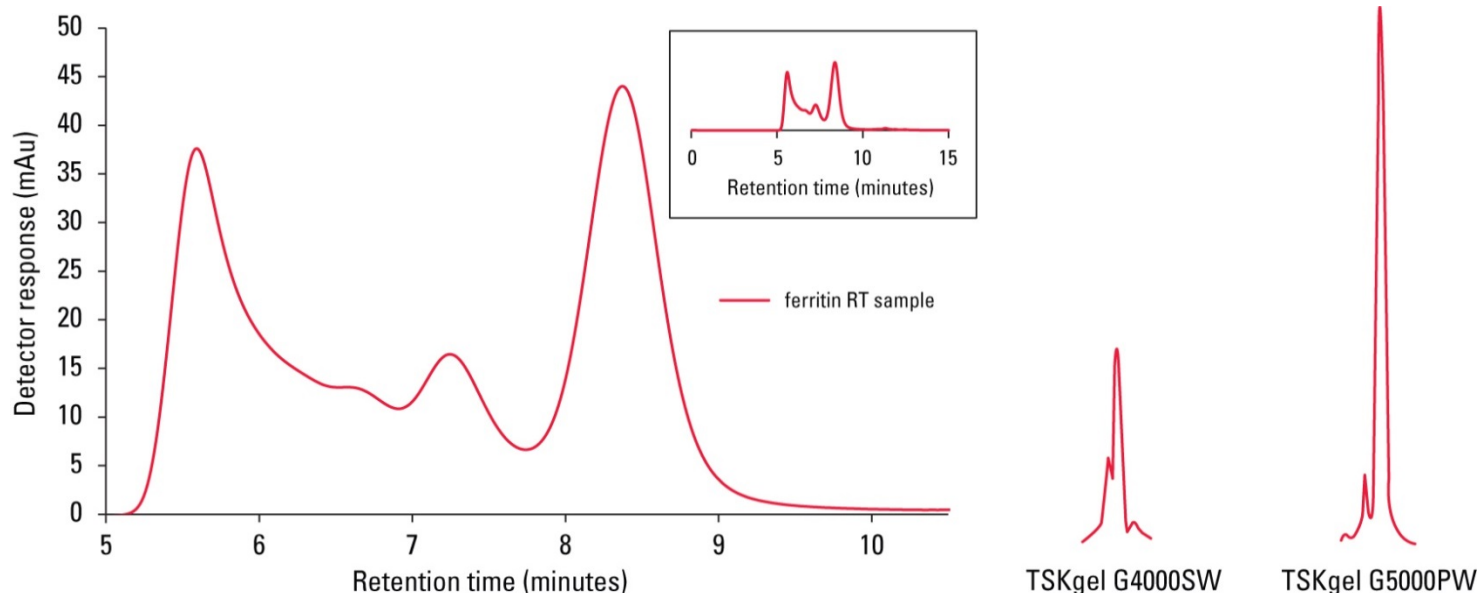

- This SEC analysis shows that ferritin at room temperature contains a considerable amount of dimer and higher order aggregates.
- These impurities could be separated using a TSKgel UltraSW Aggregate, 3 μm , 7.8 mm ID \times 30 cm column.
- The TSKgel UltraSW Aggregate column yielded better separation and resolution compared to previously reported analysis of ferritin using 17 μm TSKgel G4000SW⁴ and 17 μm TSKgel G5000PW⁴ columns containing a larger pore size of 45 nm and 100 nm respectively.

⁴Ann. Ist.Super Sanita 1989, 25(3) P481



Figure 8: Analysis of Heat Induced Forced Denatured, Large Hydrophobic Metalloprotein, Apoferritin

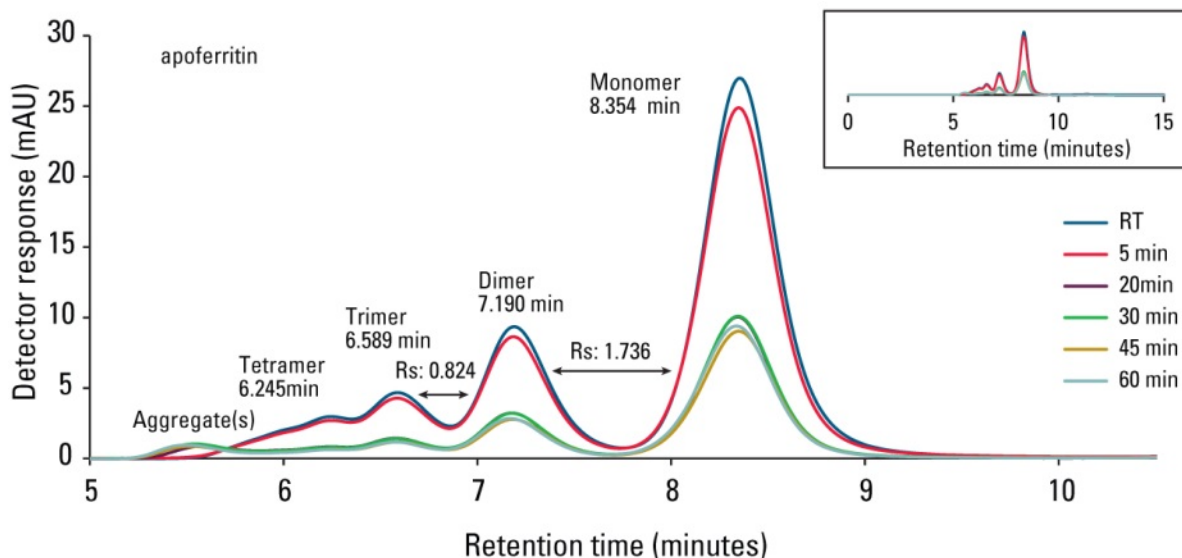

Protein	Molecular weight (kDa)			
	Monomer	Dimer	Trimer	Tetramer
ferritin and apoferritin	450	900	1350	1800

- TSKgel Ultra SW Aggregate column yielded high resolution between the monomer and dimer.
- The trimer, tetramer and higher order aggregates of apoferritin were separated.



Figure 9: Use of TSKgel UltraSW Aggregate Columns in Series to Separate Apoferritin Aggregate Resolution

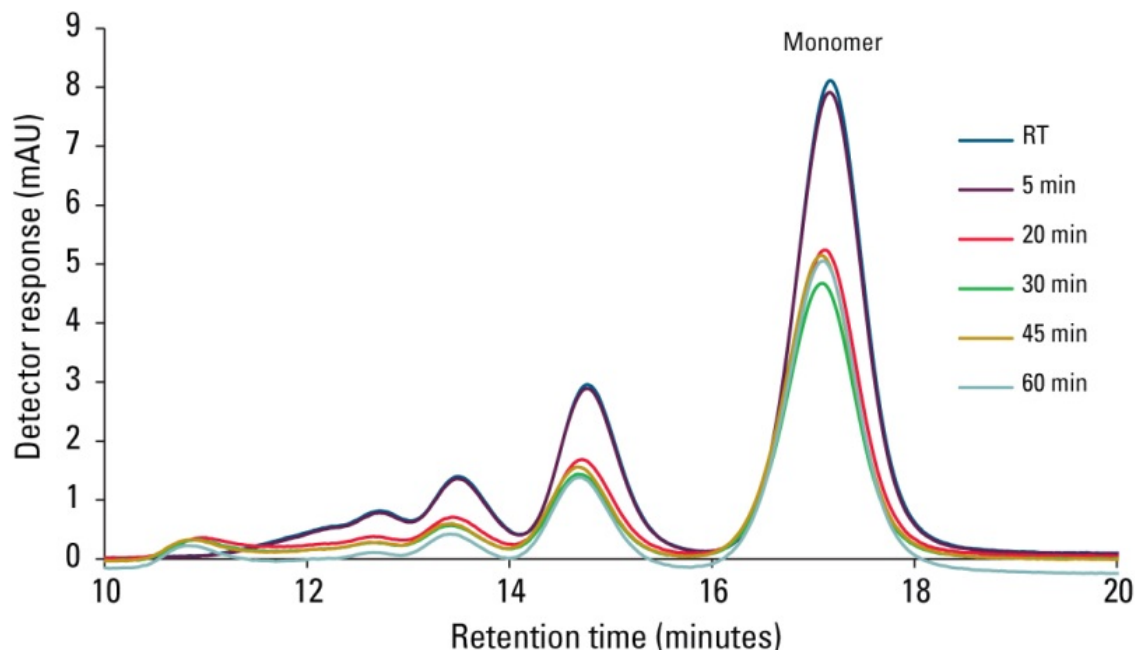

- Two TSKgel Ultra SW Aggregate columns in series yielded better resolution of higher order aggregates of apoferritin.
- An increase in peak resolution between all species is observed.
 - Resolution between monomer and dimer peak = 1.99
 - Resolution between dimer and trimer peak = 1.08
 - Resolution between trimer and aggregate peak = 1.25



Figure 10: Analysis of Collected Monomer Fraction of Ferritin

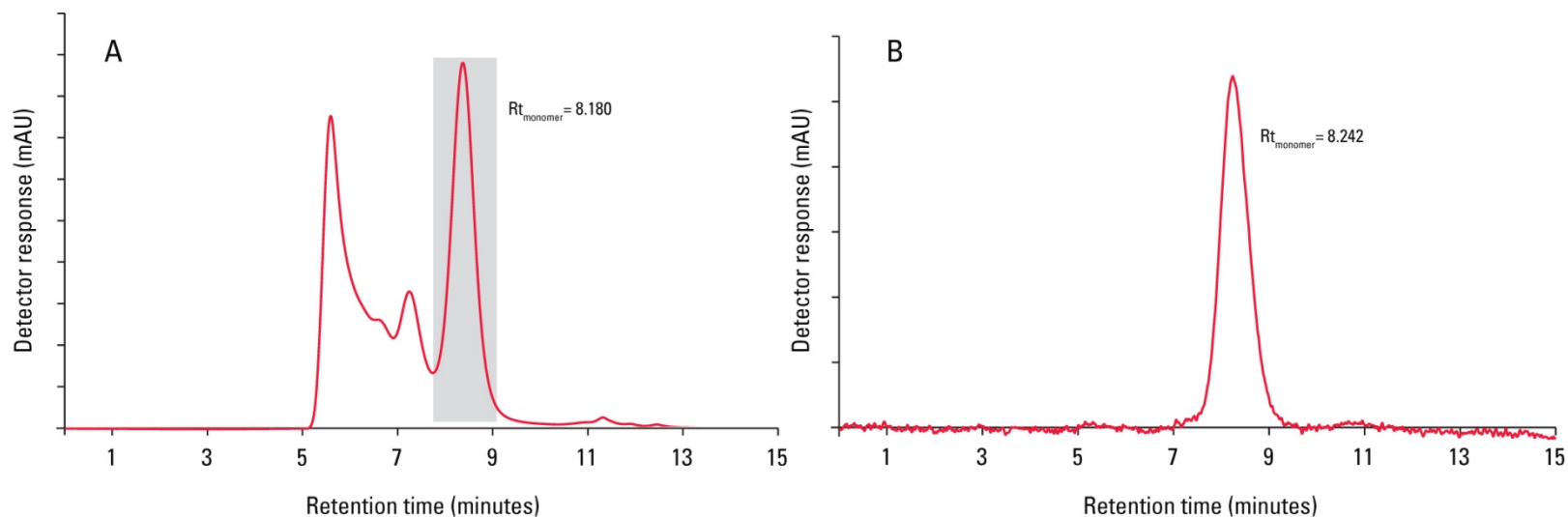

A: Analysis of ferritin using a TSKgel UltraSW Aggregate column

B: Collected ferritin fraction re-analyzed on a TSKgel UltraSW Aggregate column illustrating the presence of the monomeric species only.



Figure 11: Analysis of Collected Monomer Fraction of Apoferritin

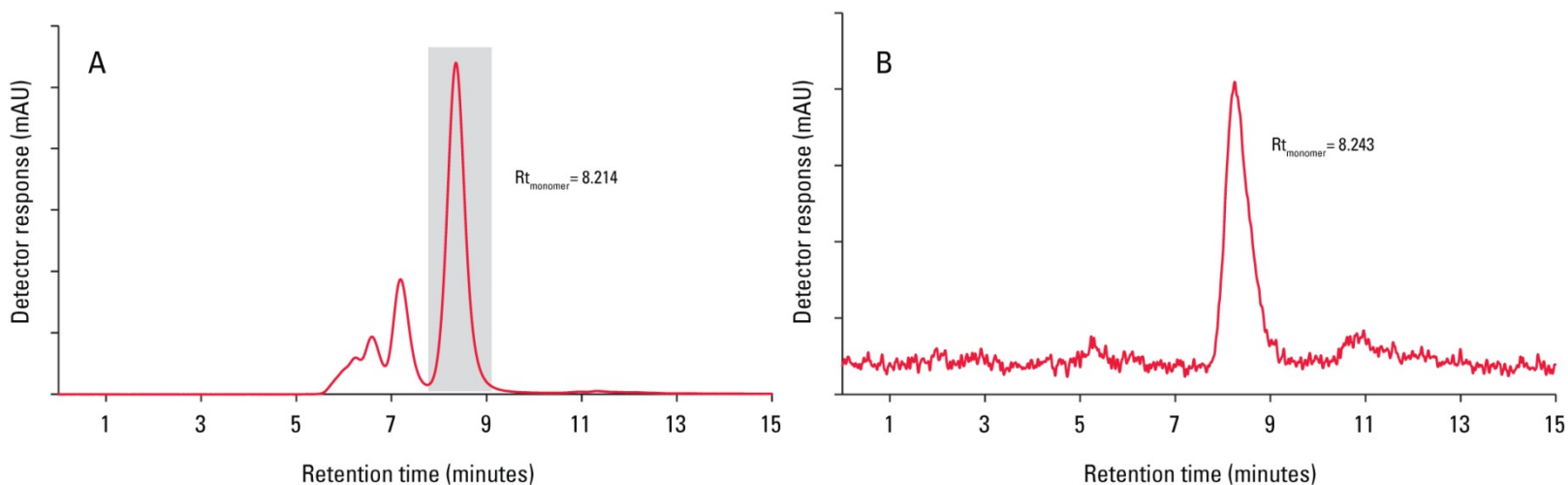

A: Analysis of apoferritin using a TSKgel UltraSW Aggregate column

B: Collected apoferritin fraction re-analyzed on a TSKgel UltraSW Aggregate column illustrating the presence of the monomeric species only.



Conclusions

- TSKgel UltraSW Aggregate is a novel 3 μm SEC column with 30 nm pore size specially designed by controlled pore technology for the separation of higher order aggregates of monoclonal antibodies.
- TSKgel UltraSW Aggregate, which possesses a larger MW exclusion limit than the conventional TSKgel G3000SW_{XL}, exhibited superior resolving power for aggregates of large proteins, including thyroglobulin and IgG.
- The performance of these columns was demonstrated by the separation of IgG fragments generated by papain digestion and separation of IgG aggregates.
- This column is also useful for the analysis of monoclonal antibody protein aggregates present under native state or when induced by acid or heat denaturation.
- The column could separate the higher order aggregates of the large metalloproteins ferritin and apoferritin present in their native state and under forced denaturation conditions.
- The TSKgel UltraSW Aggregate column is useful for the analysis of thermal properties of mAb and other proteins. The column is expected to work fine for aggregates induced by other methods such as (a) salt (b) acid and (c) proteolysis.